

SCANSTRUT.

**TILE • USB-A / USB-C
Interior Charging Socket 12/24V**

Electrical Information
& Installation Instructions

SC-TILE-10 **Black Bezel**
SC-TILE-11 **Brushed Stainless Steel Bezel**

- EN** READ THESE INSTRUCTIONS BEFORE INSTALLING THE PRODUCT
- DE** LESEN SIE DIESE ANLEITUNG DURCH, BEVOR SIE MIT DER INSTALLATION BEGINNEN
- ES** LEA ESTAS INSTRUCCIONES ANTES DE INSTALAR EL PRODUCTO
- FR** VEUILLEZ PRENDRE CONNAISSANCE DE CES INSTRUCTIONS. AVANT DE PROCÉDER À L'INSTALLATION
- IT** LEGGERE QUESTE ISTRUZIONI PRIMA DI INSTALLARE IL PRODOTTO
- FIN** LUE NÄMÄ OHJEET ENNEN TUOTTEEN ASENTAMISTA.
- SWE** LÄS DESSA INSTRUKTIONER INNAN PRODUKTEN INSTALLERAS

FCC Warning

This device complies with part 15 of the FCC Rules. Operation is subject to the following two conditions: (1) This device may not cause harmful interference, and (2) this device must accept any interference received, including interference that may cause undesired operation.

Any Changes or modifications not expressly approved by the party responsible for compliance could void the user's authority to operate the equipment.

This equipment has been tested and found to comply with the limits for a Class B digital device, pursuant to part 15 of the FCC Rules. These limits are designed to provide reasonable protection against harmful interference in a residential installation. This equipment generates uses and can radiate radio frequency energy and, if not installed and used in accordance with the instructions, may cause harmful interference to radio communications. However, there is no guarantee that interference will not occur in a particular installation.

If this equipment does cause harmful interference to radio or television reception, which can be determined by turning the equipment off and on, the user is encouraged to try to correct the interference by one or more of the following measures:

- Reorient or relocate the receiving antenna.
- Increase the separation between the equipment and receiver.
- Connect the equipment into an outlet on a circuit different from that to which the receiver is connected.
- Consult the dealer or an experienced radio/TV technician for help.

FCCRF exposure statement

The equipment complies with FCC radiation exposure limits set forth for an uncontrolled environment. During the operation of device a distance of 15 cm surrounding the device and 20 cm above the top surface of the device must be respected.

EN Warning

This product is designed for interior use only. Do not install it in any location where it may be exposed to water.

This product is to be connected to a 12V DC or 24V DC battery power source only. The power supply must be switched off before installation.

An appropriate fuse or circuit breaker must be used between the battery / power source and this product. Check for correct polarity of all wiring before switching the power on.

This product may contain high voltages. Do not tamper with the product.

This product is **NOT** approved for use in hazardous/flammable atmospheres.

DO NOT install in a hazardous/flammable atmosphere e.g. engine room.

Before drilling any holes, ensure the area behind the mounting location is clear of wires, fuel and all other hazardous objects.

Ensure any holes cut will not significantly weaken the structure of the mounting surface.

CAUTION

The product is specially designed for charging QC and PD compatible devices.

This product does not contain any user serviceable parts. DO NOT attempt to repair or modify the product in any way.

When used in high ambient temperature or in direct sunlight, the product may turn off temporarily, this is a safety feature of the electronics.

When choosing a mounting location, avoid areas exposed to heat radiation and areas with poor ventilation.

WIRING

Professional electrician installation recommended, see Technical Information for power requirements.

To achieve max power output, the specified voltage must be at the charger. Battery performance and voltage drop needs to be considered for installation.

ENVIRONMENTAL PROTECTION

Waste electrical products should not be disposed of with household waste. Please recycle where facilities exist. Check with your Local Authority or retailer for recycling advice.

IMPORTANT

Scanstrut Ltd & Inc. accepts no responsibility for any injuries or other damages arising from the use of their products in any circumstances.

WARRANTY

A 3 year, non-transferable warranty covers this Scanstrut product only and not any devices that are charged by it. No warranty is given for users' devices and users expose their devices to hazards, known or unknown, at their own risk.



Scanstrut Ltd, declares the products 'TILE' SKU: SC-TILE-10 and SC-TILE-11 are in compliance with EMC CE-RED Directive (2014/30/EU) & The CE certificate of EN55032, EN55035, EN61000, IEC EN 62368-1 conformity can be found at scanstrut.com/support/compliance

IC Statement

This class B digital apparatus complies with Canadian ICES-003 (B) / NMB-003 (B).

Cet appareil numérique est conforme à la norme NMB-003 du Canadien.

Technical Information

Input Voltage	12/24V System 10-32V DC			
Input Current Max	6A			
Output Type	12V System		24V System	
	USB-A	USB-C	USB-A	USB-C
	5V=3A, 9V=3A, 12V=3A MAX	5V=3A, 9V=3A, 12V=3A MAX	5V=3A, 9V=3A, 12V=3A MAX	5V=3A, 9V=3A, 12V=3A, 15V=3A, 20V=3A MAX
Standby Draw	< 0.1W			
Cable	18 AWG - Minimum bend rad 15mm			

Main Charging Protocol
QC = Quick Charge
PD = Power delivery

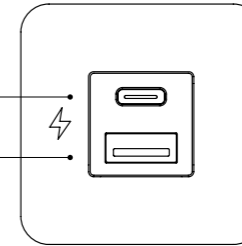

USB-C
PD 3 and QC4

USB-A
QC 3

Parts List

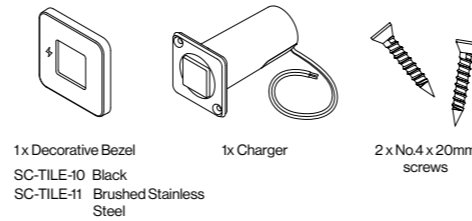

1x Decorative Bezel
SC-TILE-10 Black
SC-TILE-11 Brushed Stainless Steel

1x Charger

2x No.4 x 20mm screws

Installation

1 Drill mounting hole using hole saw

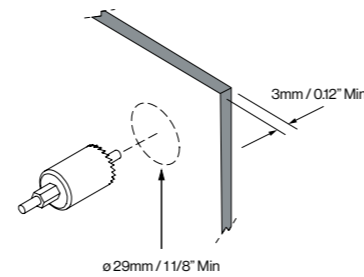

4 Clip bezel over charger

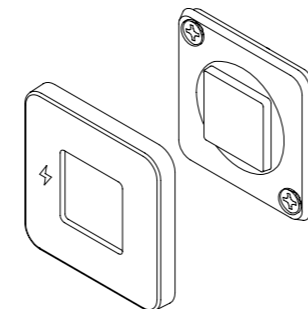

2 Connect to wiring loom pre or post panel mounting

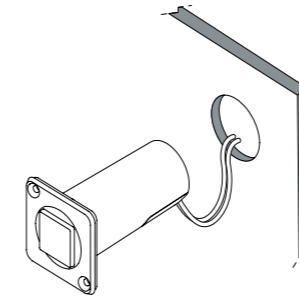

5 Connect to 12/24V supply, ensuring a waterproof connection. Fuse and select cable diameter according to input voltage and current for your specific installation.

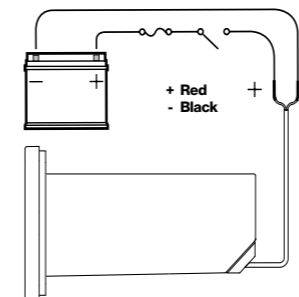

3 Drill Pilot hole suitable for substrate and fix it in place

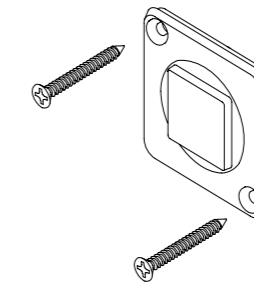

6 Use flathead screwdriver in a twisting motion on the top corner to remove the bezel.

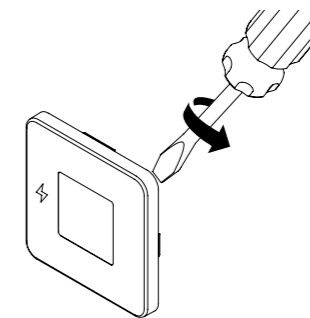

Tools Required

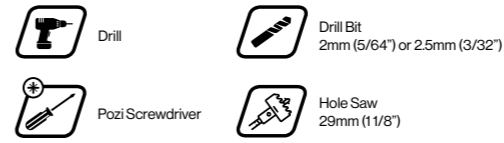

Drilling Template Scale 1:1

